

# AQUALISA

## MIDAS™

110 / 220

---

INSTALLATION INSTRUCTIONS

---



# INDEX

## INTRODUCTION

- Safety information
- Product specification

Page 3  
Page 3  
Page 3

## CONNECTION TO SUPPLIES

- Flushing
- Filters
- Isolation valves
- Pressures

Page 4  
Page 4  
Page 4  
Page 4  
Page 5

## GRAVITY SYSTEMS

- Siting
- Pump installation
- Stored water capacities

Page 5  
Page 6  
Page 6  
Page 7

## BALANCED HIGH PRESSURE SYSTEMS

Page 7

## COMBINATION BOILER SYSTEMS

Page 7

## TYPICAL WATER SYSTEMS

Page 8

## MIDAS COMPONENTS

Page 11

## VALVE INSTALLATION INSTRUCTIONS

- Midas Shower
- 110/220 adjustable height head installation
- Midas shower column
- Midas Bath/shower mixer wall mount
- Midas Bath/shower mixer deck mount

Page 13  
Page 13  
Page 16  
Page 20  
Page 25  
Page 27

## USER GUIDE

- Temperature control
- Shower On/Off/Flow control
- 110 shower column & BSM On/Off/Flow control
- 220 shower column & BSM On/Off/Flow control

Page 29  
Page 29  
Page 29  
Page 29  
Page 30

## SHOWER HEAD

Page 30

## CLEANING & MAINTENANCE

Page 31

## MIDAS RANGE COMMISSIONING

Page 32

## TROUBLE SHOOTING GUIDE

Page 33

# Important information

## INTRODUCTION

The Midas product range is available as either an exposed shower system, a column valve system, or an exposed bath/shower mixer system complete with adjustable height heads. All adjustable shower heads feature variable spray patterns. Midas thermostatic valves provide close temperature stability and fail safe protection on appropriate high and low pressure systems.

In the event of any product problems, please contact the Aqualisa customer helpline on 01959 560010 for assistance.

## Safety information

This product must be installed by a competent person in accordance with all relevant current Water Supply Regulations. The Midas range is designed for domestic use only.

## Product specification

Midas shower valves are suitable for gravity stored, gravity boosted, balanced high pressure and combination boiler systems.

Pressure range 0.1 –10 bar max (static).

Midas shower column and bath/shower mixer products are suitable for balanced high pressure, combination boiler and boosted gravity systems.

Pressure range 1.0 –10 bar max (static).

N.B. The combination boiler **MUST** have a minimum rating of 24kW (80,000 Btu) and be of the type fitted with a fully modulating gas valve.

**If in any doubt, please contact the appliance manufacturer before installation commences.**

## CONNECTION TO SUPPLIES

The Midas product range is designed for conventional supplies with **HOT** on the **LEFT** and **COLD** on the **RIGHT** as viewed from the front.

Supply lines must be flushed clear of any debris before installation of the unit. Any debris accumulation in the shower valve and head may result in damage and poor performance.

### Flushing

Some modern fluxes can be extremely corrosive and, if left in contact, will attack the working parts of this unit. All soldering must be completed and the pipework thoroughly flushed out in accordance with current Water Supply Regulations prior to connection of the product.

### Filters

To ensure optimum ongoing performance, the Midas product range is protected by inlet filter assemblies in the internal waterways. Debris accumulation may result in progressively reduced flow through the showerhead and noisy operation. As this condition is not covered by our standard warranty terms, it is suggested that the cartridge be removed and the filters checked by a competent person at least every 12 months. In the event of any difficulties please contact the Aqualisa customer helpline for assistance.

### Isolation valves

Suitable full bore isolation valves must be fitted to both supplies in accordance with current Water Supply Regulations and our terms of warranty. Due to their restrictive characteristics, stopcocks and ball type valves that reduce the pipe bore size must not be used on gravity or boosted gravity installations.

## **Pressures**

The Midas product range is designed to control static pressure up to 10 bar. Where pressures are likely to exceed 10 bar, a pressure reducing valve (PRV) must be fitted into the incoming mains supply. A setting of 3 bar is recommended. It should be noted that daytime pressures approaching 8 bar can rise above the stated maximum overnight.

A suitable PRV is available from Aqualisa.

The Midas product range is not suitable for mixed supply systems, e.g. gravity hot and mains cold.

## **GRAVITY SYSTEMS**

The Midas shower valve is suitable for use with gravity systems. Services must be installed according to good plumbing practice having regard to pipe sizing, long pipe runs and low-head situations.

The cold supply for the valve assembly must be taken directly from the cold storage system. The hot supply may be taken from the vent/draw off pipe of the hot water cylinder at a point below the cylinder connection or alternatively from the underside of the horizontal draw off. Refer to diagram on page 8 ref point A or B.

Rising pipe work must not be connected into the horizontal draw-off from the cylinder or to any point in the vent/draw off pipe above the cylinder connection.

## **CYLINDER TEMPERATURE IN EXCESS OF 65°C MAY RESULT IN POOR SHOWER PERFORMANCE.**

To minimise pressure loss we recommend that the hot and cold supplies are run in 22mm as close as reasonably possible to the mixing valve before reducing to 15mm to suit the intended inlet connection fittings.

## Siting

For optimum performance, with gravity fed systems, the distance between the bottom of the storage cistern and the shower head should not be less than 1m (when using an adjustable height shower kit). Please refer to the system layouts on page 8.

## Pump installation

**UNDER NO CIRCUMSTANCES MUST A PUMP BE FITTED DIRECTLY TO THE WATER MAIN.**

**PLEASE REFER TO THE MANUFACTURERS PUMP INSTALLATION GUIDE FOR PUMP INSTALLATION INFORMATION.**

A pump must only be used to boost the pressure from the tank-fed supplies, a typical layout is shown on page 8.

A minimum 1 bar twin ended booster pump may be fitted with **most\*** Midas products, we recommend a twin ended boost pump larger than 1 bar is used.

Due to the characteristics of the bar valve and particular site conditions, a standard twin ended pump may not be suitable due to insufficient flow to activate the pump's flow switches\*.

### **\*SPECIAL NOTES FOR SHOWER COLUMNS (MIDAS SC MODELS) & LOW FLOW / MINIMAL HEAD APPLICATIONS:**

A **universal type twin ended pump** (works in both positive and negative head conditions) is required in the below circumstances:

Shower Columns (Midas SC models) – with fixed heads where the head distance is less than 1.25m.

Low gravity flow – due to restrictions, pipe runs or where the head of water is below the minimum 1m (fixed heads 1.25m).

## **Stored water capacities**

The minimum capacity of the cold storage cistern should not be less than 225 litres (50 gallons). The capacity of the hot cylinder must be capable of meeting the anticipated demand.

## **BALANCED HIGH-PRESSURE SYSTEM**

The Midas range is designed to operate with unvented hot water storage systems up to a maximum pressure of 10 bar. The cold water supply must be drawn from the same mains supply as that to the hot water system (down stream of the cylinder manufacturers pressure limiting valve, where supplied) and the hot supply from the nearest convenient draw off point. Account must be taken of pressure drops that may occur when other draw-off points are used while the shower is in use. A typical layout is shown on page 9.

## **COMBINATION BOILER SYSTEM**

The Midas range is suitable for use with combination boiler systems. The combination boiler **MUST** have a minimum rating of 24kW (80,000 Btu) and be of the type fitted with a fully modulating gas valve. This is sufficient to operate one outlet point at a time.

For pressure refer to page 5.

The cold supply can be taken from the nearest convenient mains supply and the hot supply can be taken from the nearest hot water draw-off point. Account must be taken of the pressure drops that will occur when other draw-off points are used while the shower is in use. A typical layout is shown on page 9.

When fitted to combination boiler systems, Midas shower valves have been designed to give optimum temperature control and stability from fully modulating combination boilers and instantaneous gas water heaters.

If temperature adjustment is required, refer to cartridge adjustment instructions on page 32.

## TYPICAL GRAVITY SYSTEM INSTALLATION

(suitable for use with Midas 110/220 shower valves)

Head to be 1m minimum

Refer to page 6 (siting)

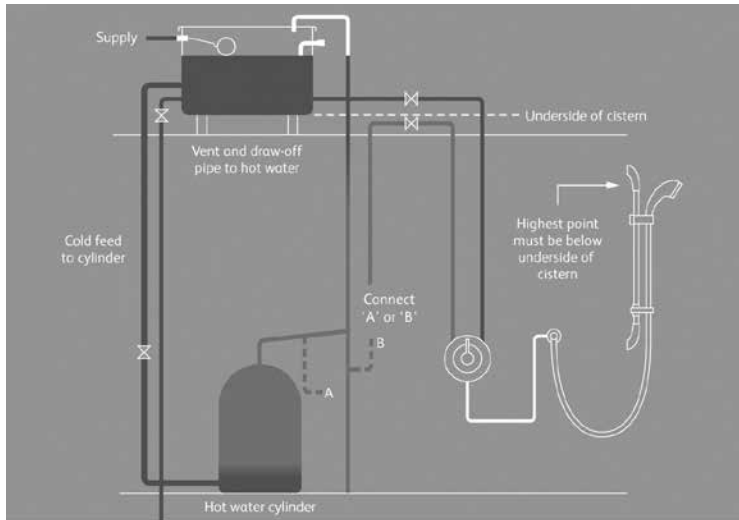

## TYPICAL GRAVITY BOOSTED SYSTEM INSTALLATION

(suitable for use with all Midas valves)

Refer to special notes on page 6\*

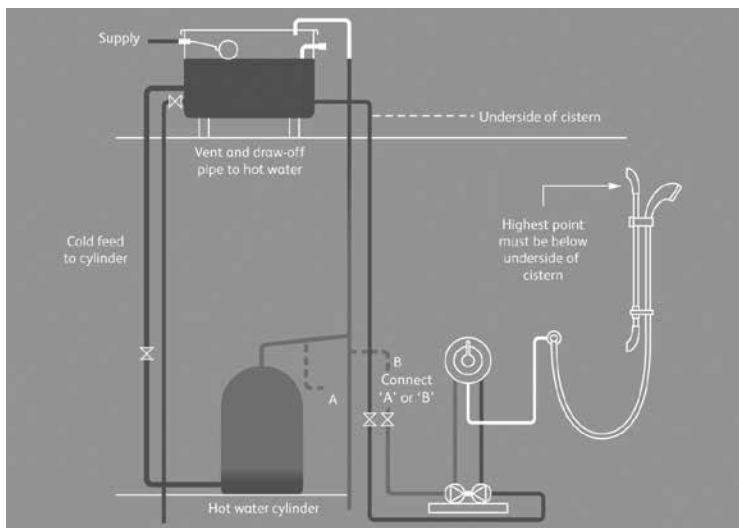



# TYPICAL COMBINATION BOILER SYSTEM INSTALLATION

(suitable for use with all Midas valves)

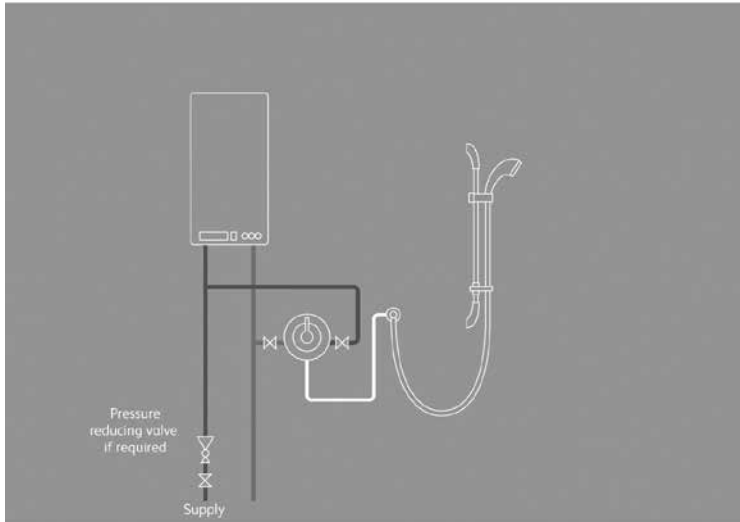

# TYPICAL UHW SYSTEM INSTALLATION

(suitable for use with all Midas valves)

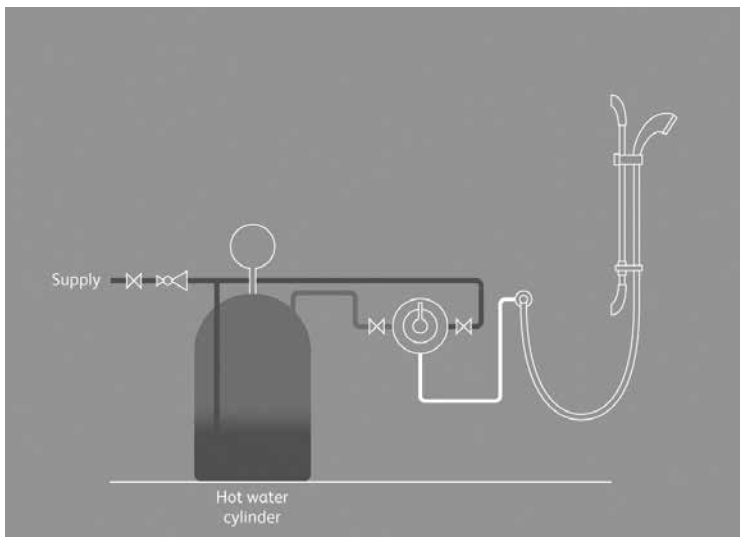

# TYPICAL THERMAL STORAGE UNIT SYSTEM INSTALLATION

(suitable for use with all Midas valves)

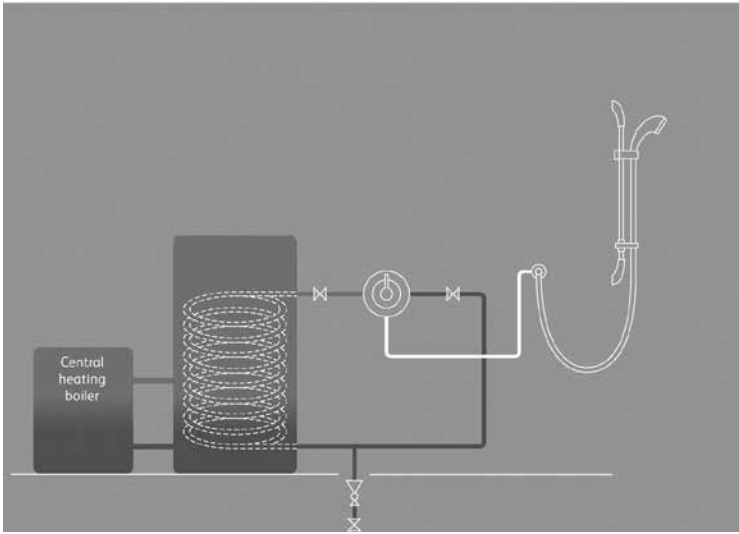

## MIDAS COMPONENTS

### Midas 110 shower

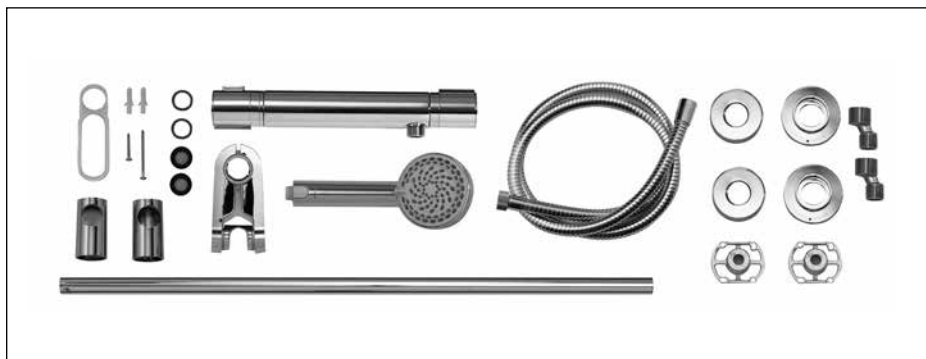

### Midas 110 shower column



### Midas 110 bath shower mixer

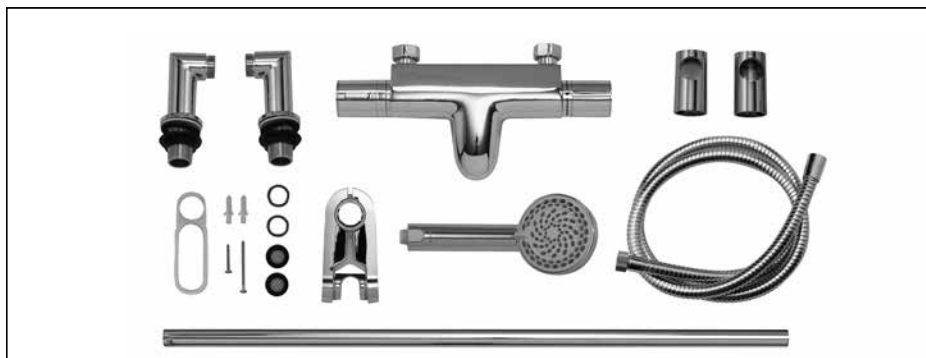

## MIDAS COMPONENTS

### Midas 220 shower

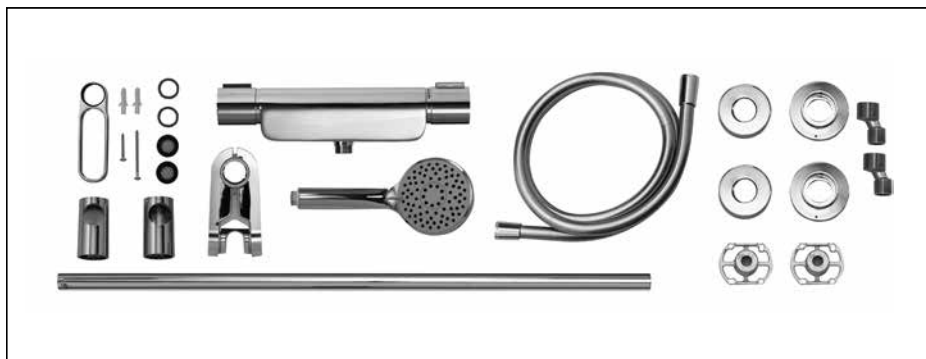

### Midas 220 shower column

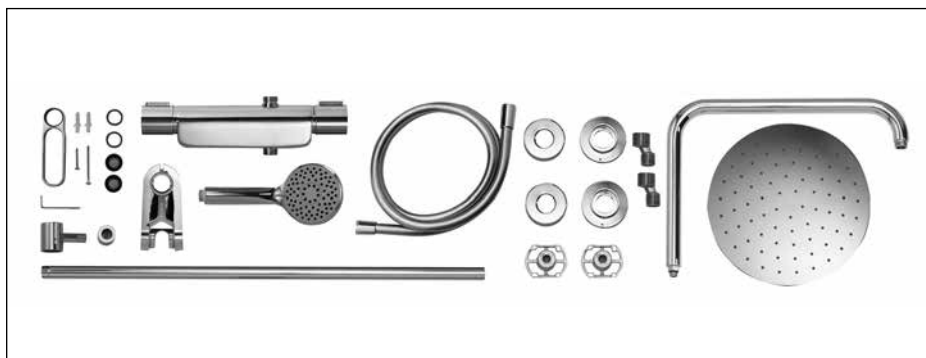

### Midas 220 bath shower mixer



# MIDAS

## SHOWER

### INSTALLATION INSTRUCTIONS



In addition to the guide below it is essential that the written instructions are read and understood and that you have all the necessary components before commencing installation. Failure to install the product in accordance with these instructions may adversely affect the warranty terms and conditions. Do not undertake any part of this installation unless you are competent to do so. Prior to starting, ensure that you are familiar with the necessary plumbing regulations required to install the product correctly and safely.

The BAR001FIX bar valve fixing kit provided with Midas 110/220 shower provides a method of surface siting exposed bar valves onto a finished wall surface, using 15mm concealed pipe work.



If required, fit the bar valve fixing accessory following the relevant installation instructions provided and proceed to step 6.

The valve and fixing bracket assembly **MUST NOT** be used as a grab rail support method.



Bar valve fixing accessories are available separately.

The MD300EFB is a first fix fixing bracket. If using the MD300EFB bracket, ensure sufficient threads are left from the finished wall surface, after the cover plates have been fitted, to ensure adequate purchase for the valve. Please refer to page 14 for recommended thread depths information.



1

Eccentric elbows are provided to allow for inlet pipework adjustment between 130mm – 170mm centres. Construct suitable connections terminating in 1/2" BSP female fittings.

All eccentric elbows provided convert from 3/4" to 1/2".





When using the eccentric elbows provided we recommend leaving sufficient threads from the finished wall surface, after the cover plates have been fitted, to ensure adequate purchase for the exposed valve. If using alternative fixings, please refer to the installation instructions provided to ensure adequate threads are left to connect the exposed valve after the cover plates have been fitted to the finished wall surface.

#### RECOMMENDED THREAD DEPTH CHART

MD110	Eccentric fittings from finished wall surface	MIN 23mm - MAX 25mm
MD220	Eccentric fittings from finished wall surface	MIN 30mm - MAX 32mm
EASY FIT BRACKET	From finished wall surface	MIN 20mm - MAX 25mm

2

If required, apply jointing tape to the threads and fit the eccentric elbow connectors sufficiently to achieve a water tight seal, terminating at 150mm centres to suit the exposed valve inlets.



3

Ensuring adequate provision to allow the water to discharge safely to waste, turn on the supplies to flush the system through. Attach pressure test equipment and pressure test the system in accordance with Water Supply Regulations.

4

Ensure the 3/4" supply connections are temporarily capped to prevent any dirt or dust ingress into the pipe work during the making good process. Remove the caps prior to connecting the shower valve.

5

Place the cover plates onto the exposed  $\frac{3}{4}$ " threads, flush with the finished wall surface and apply a thin bead of mastic if required.

**The cover plate may vary from the image shown.**

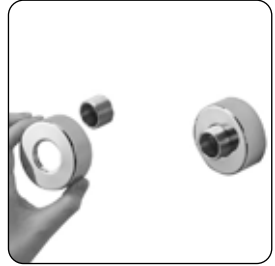

Image shows 220 cover plates

6

Ensuring the inlet washers are positioned within the valve inlets, offer the valve into position. Tighten the fixing nuts using a suitable tool taking care not to overtighten. Unless in line filters are fitted to the supply pipe work we recommend the rubber filter washers should be used.

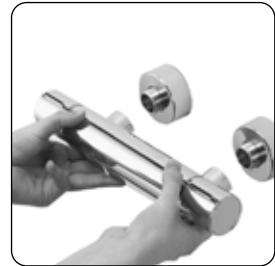

Image shows 220 shower valve

7

Ensuring the hose washer is in place, attach the hose to the valve hose outlet to allow the water to discharge safely to waste.

Turn on the supplies to the shower and turn the shower on to flush the system through. Turn off the shower.



Image shows 220 shower valve

# MIDAS

## 110/220 ADJUSTABLE HEIGHT HEAD

### INSTALLATION INSTRUCTIONS

1

Drill and prepare two fixing points between 520mm (minimum) and 830mm (maximum) apart using the fixings provided, if suitable.



**The top rail end bracket can be adjusted to suit existing screw holes in the finished wall, by sliding the bracket up or down the rail to suit the required position.**

2

Pass the rail through the handset holder while keeping the slider levers depressed. Ensure the handset holder is in the correct orientation.





3

Carefully slide the gel hook onto the rail under the handset holder.



**Current Water Supply Regulations state that the handset should not be allowed to pass a point 25mm above the spill over level of the bath or shower tray. If this cannot be achieved, the hose must be passed through the gel hook which has been designed to be utilised as a hose restraint.**

4

Secure the top rail bracket into position using the fixings provided, if suitable.

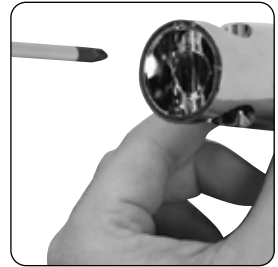

5

Slide the rail assembly up through the top rail end bracket.



6

Align the small hole in the rail with the bottom rail end fixing point. Secure the rail assembly to the wall, using the fixings provided, if suitable, taking care to not over tighten.

7

Place the rail end caps into the rail ends and push firmly into position.



8

Pass the hose through the gel hanger. Connect the longer conical connection to the shower head and connect the shorter conical connection to the valve.



## Midas 110 shower head attachment

9

Ensuring the hose washers are in the correct position, depress the anti-swivel locking button on the handset and secure the handset to the hose. Place the handset into the handset holder.



10

## Midas 220 shower head attachment

Ensuring the hose washers are in the correct position, offer the hose onto the handset. Push the handset onto the hose to lock the anti-kink swivel connector and secure the handset to the hose. Once tightened, carefully pull the handset away from the hose to release the integral anti-kink swivel connection. Place the handset into the handset holder.



# MIDAS

## SHOWER COLUMN

### INSTALLATION INSTRUCTIONS



In addition to the guide below it is essential that the written instructions are read and understood and that you have all the necessary components before commencing installation. Failure to install the product in accordance with these instructions may adversely affect the warranty terms and conditions. Do not undertake any part of this installation unless you are competent to do so. Prior to starting ensure that you are familiar with the necessary plumbing regulations required to install the product correctly and safely.

The BAR001FIX bar valve fixing kit provided with Midas 110/220 shower column provides a method of surface siting exposed bar valves onto a finished wall surface, using 15mm concealed pipe work.



If required, fit the bar valve fixing accessory following the relevant installation instructions provided and proceed to step 6.

The valve and fixing bracket assembly **MUST NOT** be used as a grab rail support method.



Bar valve fixing accessories are available separately. The MD300EFB is a first fix fixing bracket. If using the MD300EFB bracket, ensure sufficient threads are left from the finished wall surface, after the cover plates have been fitted, to ensure adequate purchase for the valve. Please refer to page 14 for recommended thread depths information.



### A MINIMUM CLEARANCE OF 1.2M FROM THE TOP OF THE SHOWER VALVE IS REQUIRED TO INSTALL THE SHOWER COLUMN.

1

Eccentric elbows are provided to allow for inlet pipework adjustment between 130mm – 170mm centres. Construct suitable connections terminating in 1/2" BSP female fittings.



When using the eccentric elbows provided we recommend leaving sufficient threads from the finished wall surface, after the cover plates have been fitted, to ensure adequate purchase for the exposed valve. If using alternative fixings please refer to the installation instructions provided to ensure adequate threads are left to connect the valve after the cover plates have been fitted to the finished wall surface. Please refer to page 14 for recommended thread depths information.

2

If required, apply jointing tape to the threads and fit the eccentric elbow connectors sufficiently to achieve a water tight seal, terminating at 150mm centres to suit the exposed valve inlets.



3

Ensuring adequate provision to allow the water to discharge safely to waste, turn on the supplies to flush the system through. Attach pressure test equipment and pressure test the system in accordance with Water Supply Regulations.

4

Ensure the  $\frac{3}{4}$ " supply connections are temporarily capped to prevent any dirt or dust ingress into the pipe work during the making good process. Remove the caps prior to connecting the shower valve.

5

Place the cover plates onto the exposed  $\frac{3}{4}$ " threads, flush with the finished wall surface and apply a thin bead of mastic if required.

**The cover plates may vary from the image shown.**

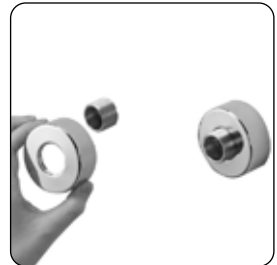

Image shows 220 cover plates

6

Ensuring the inlet washers are positioned within the valve inlets, offer the valve into position. Tighten the fixing nuts using a suitable tool taking care not to overtighten. Unless in line filters are fitted to the supply pipe work we recommend the rubber filter washers should be used.



Image shows 220 shower column valve

7

Attach the wall fixing bracket to the riser rail connector.



8

Attach the fixed riser arm to the riser rail connector rotating the riser rail until it tightens. Using the hexagonal key supplied tighten the grub screw in the wall fixing bracket to secure the riser rail connector.



9

Position the riser rail assembly onto the mixer valve outlet ensuring the washer is in place. Tighten the fixing nut hand tight.



10

Ensuring the riser rail assembly has been correctly positioned and attached to the mixer valve, mark the position of the wall fixing bracket. Remove the riser rail assembly from the valve and remove the wall fixing bracket assembly from the riser rail assembly.



11

Place the wall fixing plate into position and mark and prepare the fixing points using the fixings provided, if suitable. Secure the wall fixing bracket to the wall using the screws provided, if suitable.



12

Ensuring the fixed head washer is in place, carefully screw the shower head to the fixed riser arm taking care not to damage the plated surface. Carefully tighten the shower head with a suitable tool taking care not to overtighten.



13

Pass the bottom of the riser rail through the handset holder while keeping the slider levers depressed. Ensure the handset holder is in the correct orientation.



14

Re-position the riser rail assembly onto the mixer valve outlet. Tighten the fixing nut using a suitable tool, taking care not to overtighten.



15

Carefully position the riser rail connector so it engages into the wall fixing bracket and secure via the grub screw on the bottom wall fixing bracket using the hexagonal key provided.



16

Ensuring the hose washer is in place, attach the hose to the hose outlet, taking care not to overtighten. Turn the shower on towards the wall to allow the water to discharge safely to waste and run the shower for a few seconds to clear any debris in the outlet assembly. This process can also be repeated for the fixed head by adjusting the control knob away from the wall.



17

### Midas 110 shower head attachment

Ensuring the hose washers are in the correct position, depress the anti-swivel locking button on the handset and secure the handset to the hose. Place the handset into the handset holder.



18

### Midas 220 Shower Head Attachment

Ensuring the hose washers are in the correct position, offer the hose onto the handset. Push the handset onto the hose to lock the anti-kink swivel connector and secure the handset to the hose. Once tightened, carefully pull the handset away from the hose to release the integral anti-kink swivel connection.

Place the handset into the handset holder.





# MIDAS

## BATH SHOWER MIXER - DECK MOUNT

### INSTALLATION INSTRUCTIONS



The Midas range bath shower mixers feature inlet pipe centres of 150mm. However deck mount adaptors are provided to allow installation to baths at standard 180mm centres.

1

Ensuring the inlet washers are fitted within the valve inlets, attach the deck mount adaptors to the bath/shower mixer. Tighten the connections using a suitable tool, taking care not to overtighten. Unless in line filters are fitted to the supply pipe work we recommend the rubber filter washers should be used.



2

Place the rubber deck washers onto the tap tails and offer the assembly into position onto the bath.



3

Place the back nuts onto the tap tails and secure the assembly to the underside of the bath.

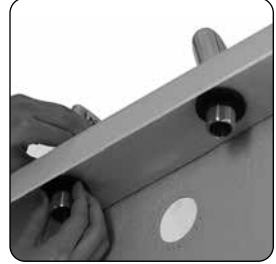

4

Using suitable connections, connect the tap tails to the hot and cold supplies.

5

Turn on the supplies to the bath/shower mixer and turn the flow control knob on to flush the system through. Turn off the bath/shower mixer and attach the hose, ensuring the hose washer is in place.

6

Follow the Midas 110/220 adjustable height head installation on page 16 to complete the installation.



If required, refer to the commissioning instructions on page 32 to adjust the maximum temperature override button position.

# MIDAS

## BATH SHOWER MIXER - WALL MOUNT

### INSTALLATION INSTRUCTIONS



In addition to the guide below it is essential that the written instructions are read and understood and that you have all the necessary components before commencing installation. Failure to install the product in accordance with these instructions may adversely affect the warranty terms and conditions. Do not undertake any part of this installation unless you are competent to do so. Prior to starting ensure that you are familiar with the necessary plumbing regulations required to install the product correctly and safely.

Bar valve fixing accessories are available separately.

The MD300EFB is a first fix fixing bracket. If using the MD300EFB bracket, ensure sufficient threads are left from the finished wall surface, after the cover plates have been fitted, to ensure adequate purchase for the exposed valve. Please refer to page 14 for recommended thread depths information.



The BAR001FIX bar valve fixing kit accessory is available separately, to provide a method of surface siting exposed bar valves onto a finished wall surface, using 15mm concealed pipe work.

If required, fit the bar valve fixing accessory following the relevant installation instructions provided with the accessory kit and proceed to step 5.

The exposed valve and fixing bracket assembly **MUST NOT** be used as a grab rail support method.



1

Construct suitable connections at 150mm centres terminating in  $\frac{3}{4}$ " BSP male threads (available separately from Aqualisa customer services, part no. 525301 (Midas 110), part no. 910549 (Midas 220)).

2

Ensuring adequate provision to allow the water to discharge safely to waste, turn on the supplies to flush the system through. Attach pressure test equipment and pressure test the system in accordance with Water Supply Regulations.

3

Ensure the  $\frac{3}{4}$ " supply connections are temporarily capped to prevent any dirt or dust ingress into the pipe work during the making good process. Remove the caps prior to connecting the shower valve.

4

Inlet pipe cover plates are available separately from Aqualisa customer services, supplied with part no. 525301 (Midas 110), part no. 910549 (Midas 220) or complete with the easy fit fixing bracket (not supplied). If required, apply a thin bead of mastic to the rear of the cover plates. Place the cover plates onto the exposed  $\frac{3}{4}$ " threads flush with the finished wall surface.



5

Ensuring the inlet washers are positioned within the valve inlets, offer the valve into position. Tighten the fixing nuts using a suitable tool taking care not to overtighten. Unless in line filters are fitted to the supply pipe work we recommend the rubber filter washers should be used.

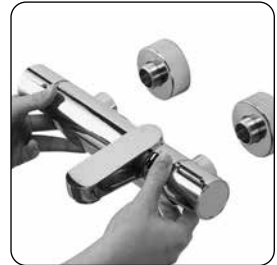

6

Turn on the supplies to the bath/shower mixer and turn the flow control knob on to flush the system through. Turn off the bath/shower mixer and attach the hose, ensuring the hose washer is in place.

7

Follow the Midas 110/220 adjustable height head installation on page 16 to complete the installation.



**If required, refer to the commissioning instructions on page 32 to adjust the maximum temperature override button position.**

# USER GUIDE

## MIDAS RANGE

### VALVE

#### 1 Temperature control

##### Left side control knob as viewed from the front

The valve is in the mid blend position when the temperature override button is at the top. The shower's outlet temperature may vary to the indicator, depending on the temperature of the incoming supplies. Using the temperature markings as a guide, depress the temperature override button and slowly rotate the knob towards the wall to increase the temperature and away from the wall to decrease the temperature.



**N.B. SHOULD IT BE NECESSARY TO RESET THE MAXIMUM TEMPERATURE POSITION, PLEASE REFER TO THE COMMISSIONING INSTRUCTIONS ON PAGE 32.**

We recommend the **MAXIMUM** outlet temperature is set to 46°C.

#### 2 Shower On/Off/Flow control

##### Right side control knob as viewed from the front

Turn the valve on by carefully rotating the flow control knob away from the wall until the required volume of flow is reached. Turn the valve off by rotating the flow control knob towards the wall until a stop is reached.



**N.B. WITH ALL MIDAS VALVES FITTED TO COMBINATION BOILER SYSTEMS, IT MAY BE NECESSARY TO ADJUST THE FLOW CONTROL KNOB AND REDUCE THE FLOW TO ACHIEVE A COMFORTABLE SHOWERING AND BATHING TEMPERATURE.**

#### 3 110 Shower Column & BSM On/Off/Flow/divert

##### Right side control knob as viewed from the front

Turn the valve on by rotating the control knob away from the wall to operate the fixed head/bath filler, or towards the wall to operate the adjustable height head. Turn the valve off by rotating the control knob to the centre until a stop is reached and the nodule is pointing upwards.

## **4** 220 Shower Column & BSM/On/Off/Flow/divert Right side control knob as viewed from the front

Turn the valve on by rotating the control knob towards the wall to operate the fixed head/bath filler, or away from the wall to operate the adjustable height head. Turn the valve off by rotating the control knob to the centre until a stop is reached and the nodule is pointing upwards.

## **SHOWER HEAD**

### **1** NEVER ATTEMPT TO MAKE ANY ADJUSTMENT TO THE SHOWER HEAD BY PULLING ON THE SHOWER HOSE.

Depress the slider levers on the handset holder to enable the shower head to be moved up or down the rail to the preferred height.



### **2** Angular adjustment is made by carefully but firmly pulling forwards, or pushing back the shower head against the knuckle ratchet in the holder.



**3**

Rotate the spray plate lever clockwise or anti-clockwise to select the desired spray pattern.

**N.B. ON THE MIDAS 110 HARMONY HEAD, WHEN THE LEVER IS IN THE 3 O'CLOCK POSITION WHEN VIEWED FROM BELOW, THE WATER SAVING MODE IS SELECTED. THIS PROVIDES THE SAME SPRAY PATTERN AS POSITION 3, BUT, DEPENDING ON WHICH WATER SYSTEM THE PRODUCT IS FITTED TO, OFFERS UP TO 25% WATER SAVING.**



## CLEANING & MAINTENANCE

Your Midas shower system should be cleaned using only a soft cloth and washing up liquid.

### **! DO NOT USE ABRASIVE CLEANERS.**

To reduce the need for chemical descaling in hard water areas, your shower head incorporates a 'clear flow' system, whereby any scale build up can be broken down by gently rubbing the flexible tips of the jets during use. This procedure should be completed regularly, as often as once a week in some hard water areas, as scale build up can affect the spray pattern and cause the shower to perform poorly. Failure to descale the shower head can affect the internal seals and may affect the warranty.

Should chemical descaling of the head become necessary, remove the shower head fully and immerse in a mild proprietary descalent.

**IT IS IMPERATIVE THAT DESCALING IS CARRIED OUT STRICTLY IN ACCORDANCE WITH THE MANUFACTURERS INSTRUCTIONS. SUBSTANCES THAT ARE NOT SUITABLE FOR PLASTICS AND ELECTROPLATED SURFACES MUST NOT BE USED.**

# MIDAS RANGE COMMISSIONING

**THE MIDAS PRODUCT RANGE IS PRE-SET TO A SAFE MAXIMUM SHOWER TEMPERATURE. SHOULD IT BE NECESSARY TO RESET THE MAXIMUM TEMPERATURE POSITION, PLEASE OBSERVE THE FOLLOWING PROCEDURE.**

**WE RECOMMEND THE MAXIMUM OUTLET TEMPERATURE IS SET TO 46°C.**

1. Ensure that the hot water system is at normal maximum temperature.
2. Turn the temperature control knob to the mid-blend position (with the button at the top of the knob).
3. Carefully remove the end cover cap using a small flat bladed screwdriver if necessary.
4. Remove the central fixing screw, pull the knob clear and set aside.
5. Turn the valve on.
6. Using a digital thermometer, adjust the temperature control to the required MAXIMUM temperature setting. We recommend the MAXIMUM outlet temperature is set to 46°C.

Adjust the temperature by small movements of the central spline hotter or colder as required. One spline adjustment is approximately 2°C.

If required, rotate one spline at a time and check outlet temperature.

Note: for factory settings markings are aligned, see image 1.



Image 1.



Image 2.

7. Turn the valve off.
8. Ensuring the temperature override button is pushed in, replace the knob onto the valve in the mid blend position.
9. Secure the knob to the valve and refit the knob insert.

**SHOULD UNACCEPTABLE DAMAGE TO THE TEMPERATURE KNOB END CAP OCCUR WHEN REMOVING IT FROM THE TEMPERATURE KNOB, PLEASE CONTACT AQUALISA CUSTOMER SERVICE ON 01959 560010 TO ARRANGE A REPLACEMENT.**



# TROUBLE SHOOTING GUIDE

SYMPTOM	POSSIBLE CAUSE	ACTION
Water output is either all hot or all cold, or cold only	Reverse inlet supplies	Check that the supplies correspond with the inlet markings
Water output is not hot enough	<p>The temperature of the hot water cylinder is too low</p> <p>Water flow through the hot water appliance is too fast</p> <p>Water flow through the hot water appliance is too fast (If fitted on a combination boiler)</p>	<p>The cylinder temperature should be at least 15°C hotter than the blend</p> <p>Check the flow rate recommendations with the heater manufacturer</p> <p>Adjust the flow control knob on the mixer valve to reduce flow until a comfortable showering or bathing temperature is achieved</p>
Flow rate is poor and water temperature is low	Airlock in the hot water supply (gravity or pumped systems only)	Check the pipework is laid out in accordance with correct practices, paying particular attention to potential air-traps
Water temperature swings regularly between hot and cold	Cold water pressure is too high	If the static water pressure exceeds 10 bar, install a pressure reducing valve (PRV) in accordance with the installation guide
Poor flow rate	<p>Twisted hose</p> <p>Debris in shower head</p> <p>Debris in filters</p>	Check for debris and clear as necessary

# NOTES

---

---

---

---

---

---

---

---

---

---

---

---

---

---

---

---

---

---

---

---

---

---

---

---

---



# AQUALISA

Aqualisa Products Limited  
The Flyers Way  
Westerham Kent TN16 1DE

Customer Helpline: 01959 560010 | Brochure Hotline: 0800 652 3669  
Website: [www.aqualisa.co.uk](http://www.aqualisa.co.uk) | Email: [enquiries@aqualisa.co.uk](mailto:enquiries@aqualisa.co.uk)  
Warranty: [www.aqualisa.co.uk/warranty](http://www.aqualisa.co.uk/warranty)

Republic of Ireland  
Sales enquiries: 01-864-3363  
Service enquiries: 01-844-3212



Please note that calls may be recorded for training and quality purposes.

The company reserves the right to alter, change or modify the product specifications without prior warning.

™ Trademark of Aqualisa Products Limited.



Part No: 702042 Issue 02 September 20